

Udaya Public School, Ayodhya
Second Pre-Board Examination 2023-24
Class X Subject: Mathematics

Time: 3 Hours

MM: 80

General Instruction:

1. This Question Paper has 5 Sections A-E.
2. **Section A** has 20 MCQs carrying 1 mark each.
3. **Section B** has 5 questions carrying 02 marks each.
4. **Section C** has 6 questions carrying 03 marks each.
5. **Section D** has 4 questions carrying 05 marks each.
6. **Section E** has 3 case based integrated units of assessment (04 marks each) with sub-parts of the values of 1, 1 and 2 marks each respectively.
7. All Questions are compulsory. However, an internal choice in 2 Qs of 5 marks, 2 Qs of 3 marks and 2 Questions of 2 marks has been provided. An internal choice has been provided in the 2marks questions of Section E
8. Draw neat figures wherever required. Take $\pi = 22/7$ wherever required if not stated.

SECTION – A

Questions 1 to 20 carry 1 mark each.

1. Three cubes each of side 15 cm are joined end to end. The total surface area of the cuboid is:
(a) 3150 cm^2 (b) 1575 cm^2 (c) 1012.5 cm^2 (d) 576.4 cm^2
2. The midpoint of a line segment joining two points A(2, 4) and B(-2, -4) is
(a) (-2, 4) (b) (2, -4) (c) (0, 0) (d) (-2, -4)
3. If the distance between the points A(2, -2) and B(-1, x) is equal to 5, then the value of x is:
(a) 2 (b) -2 (c) 1 (d) -1
4. If $\cos A = 4/5$, then the value of $\tan A$ is
(a) $3/5$ (b) $3/4$ (c) $4/3$ (d) $5/3$
5. If $\cos \theta + \cos^2 \theta = 1$, the value of $\sin^2 \theta + \sin^4 \theta$ is :
(a) -1 (b) 0 (c) 1 (d) 2
6. The HCF and the LCM of 12, 21, 15 respectively are
(a) 3, 140 (b) 12, 420 (c) 3, 420 (d) 420, 3
7. If the sum of LCM and HCF of two numbers is 1260 and their LCM is 900 more than their HCF, then the product of two numbers is
(a) 205400 (b) 203400 (c) 194400 (d) 198400
8. If the zeroes of the quadratic polynomial $x^2 + (a + 1)x + b$ are 2 and -3, then
(a) $a = -7, b = -1$ (b) $a = 5, b = -1$ (c) $a = 2, b = -6$ (d) $a = 0, b = -6$
9. In the given figure, from an external point P, two tangents PQ and PR are drawn to a circle of radius 4 cm with centre O. If $\angle QPR = 90^\circ$, then length of PQ is

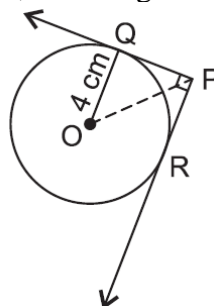

- (a) 3 cm (b) 4 cm (c) 2 cm (d) 2.2 cm

10. In the given figure, quadrilateral ABCD is circumscribed, touching the circle at P, Q, R and S such that $\angle DAB = 90^\circ$, If $CR = 23$ cm and $CB = 39$ cm and the radius of the circle is 14 cm, then the measure of AB is

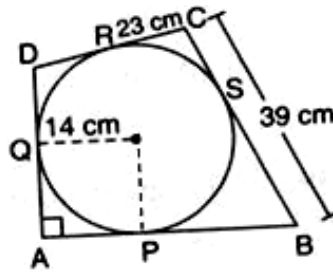

- (a) 37 cm (b) 16cm (c) 30 cm (d) 39 cm
11. If the circumference of a circle increases from 2π to 4π then its areathe original area :
- (a) Half (b) Double (c) Three times (d) Four times
12. In the figure given below, $AD = 4$ cm, $BD = 3$ cm and $CB = 12$ cm, then $\cot \theta$ equals :

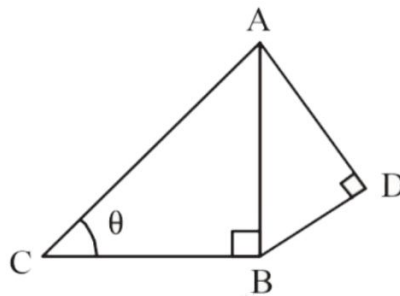

- (a) $3/4$ (b) $5/12$ (c) $4/3$ (d) $12/5$
13. The perimeters of two similar triangles are 26 cm and 39 cm. The ratio of their corresponding sides:
- (a) $2 : 3$ (b) $6 : 9$ (c) $4 : 6$ (d) $4 : 9$
14. If $\Delta ABC \sim \Delta EDF$ and ΔABC is not similar to ΔDEF , then which of the following is not true?
- (a) $BC \cdot EF = AC \cdot FD$ (b) $AB \cdot EF = AC \cdot DE$ (c) $BC \cdot DE = AB \cdot EF$ (d) $BC \cdot DE = AB \cdot FD$
15. The radii of 2 cylinders are in the ratio $2 : 3$ and their heights are in the ratio $5 : 3$. Then, the ratio of their volumes is:
- (a) $19 : 20$ (b) $20 : 27$ (c) $18:25$ (d) $17:23$

16. Consider the following frequency distribution

Class	0 – 5	6 – 11	12 – 17	18 – 23	24 – 29
Frequency	13	10	15	8	11

The upper limit of the median class is

- (a) 7 (b) 17.5 (c) 18 (d) 18.5
17. Consider the following distribution:

Marks obtained	Number of students
More than or equal to 0	63
More than or equal to 10	58
More than or equal to 20	55
More than or equal to 30	51
More than or equal to 40	48
More than or equal to 50	42

the frequency of the class 30-40 is

- (a) 4 (b) 48 (c) 51 (d) 3

18. Two dice are thrown simultaneously. The probability that the product of the numbers appearing on the dice is 7 is
 (a) $7/36$ (b) $2/36$ (c) 0 (d) $1/36$

Direction : In the question number 19 & 20 , A statement of Assertion (A) is followed by a statement of Reason(R) . Choose the correct option

19. **Assertion (A):** The mid-point of the line segment joining the points A (3, 4) and B (k, 6) is P (x, y) and $x + y - 10 = 0$, the value of k is 7

Reason (R): Midpoint of line segment is $\left(\frac{x_1 + x_2}{2}, \frac{y_1 + y_2}{2}\right)$

- (a) Both A and R are true and R is the correct explanation of A
 (b) Both A and R are true but R is not the correct explanation of A
 (c) A is true and R is false
 (d) A is false and R is true
20. **Assertion (A):** For any two positive integers a and b, $HCF(a, b) \times LCM(a, b) = a \times b$
Reason (R): The HCF of two numbers is 5 and their product is 150. Then their LCM is 40.
 (a) Both Assertion (A) and Reason (R) are true and Reason (R) is the correct explanation of Assertion (A)
 (b) Both assertion (A) and reason (R) are true and reason (R) is not the correct explanation of Assertion (A)
 (c) Assertion (A) is true but reason(R) is false.
 (d) Assertion (A) is false but reason(R) is true.

SECTION-B

Questions 21 to 25 carry 2M each

21. A quadrilateral ABCD is drawn to circumscribe a circle. Prove that $AB + CD = AD + BC$.

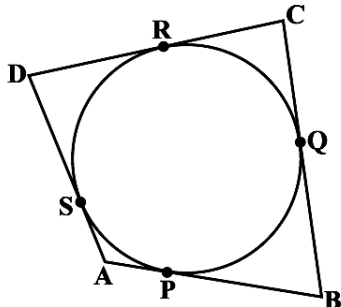

22. In the figure, $\frac{QR}{QS} = \frac{QT}{PR}$ and $\angle 1 = \angle 2$, Show that $\Delta PQS \sim \Delta TQR$.

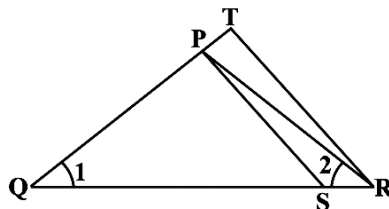

OR

ABCD is a trapezium in which $AB \parallel CD$ and its diagonals intersect each other at the point O.

Using a similarity criterion of two triangles, show that $\frac{OA}{OC} = \frac{OB}{OD}$

23. If $\sin(A - B) = \frac{1}{2}$, $\cos(A + B) = \frac{1}{2}$, $0^\circ < A + B \leq 90^\circ$, $A > B$. Find A and B.
24. Find the value of p if the pair of equations $2x + 3y - 5 = 0$ and $px - 6y - 8 = 0$ has a unique solution.

25. The short and long hands of a clock are 4 cm and 6 cm long respectively. Find the sum of distances travelled by their tips in 2 days

OR

A car has two wipers which do not overlap. Each wiper has a blade of length 21 cm sweeping through an angle of 120° . Find the total area cleaned at each sweep of the blades

SECTION-C

Questions 26 to 31 carry 3 marks each

26. 4 Bells toll together at 9.00 am. They toll after 7, 8, 11 and 12 seconds respectively. How many times will they toll together again in the next 3 hours?

OR

Given that $\sqrt{3}$ is irrational, prove that $(2 + 5\sqrt{3})$ is an irrational number.

27. Find the ratio in which the line $2x + y - 4 = 0$ divides the line segment joining the points A (2, -2) and B (3, 7)

28. In the given figure, PA and PB are the tangent segments to a circle with centre O. Show that the points A, O, B and P are concyclic.

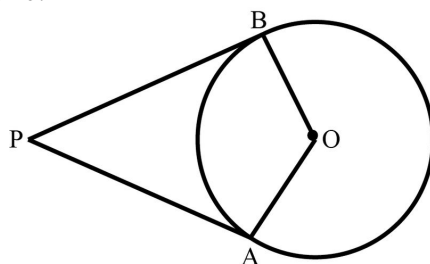

OR

In the given figure, ABC is a triangle in which $\angle B = 90^\circ$, BC = 48 cm and AB = 14 cm. A circle is inscribed in the triangle, whose centre is O. Find radius r of in-circle.

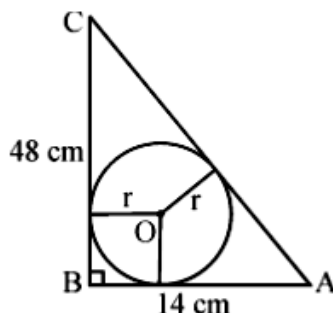

29. From a pack of 52 playing cards, jacks, queens, kings and aces of red colour are removed. From the remaining a card is drawn at random. Find the probability that the card drawn is (i) a black queen (ii) a red card (iii) a face card.

30. If a, b are the zeroes of the polynomial $2x^2 - 5x + 7$, then find a polynomial whose zeroes are $2a + 3b$, $3a + 2b$

31. Prove that $\frac{\cos A}{1 + \sin A} + \frac{1 + \sin A}{\cos A} = 2 \sec A$

SECTION-D

Questions 32 to 35 carry 5M each

32. The mean of the following frequency distribution is 62.8 and the sum of all the frequencies is 50. Compute the missing frequencies f_1 and f_2 .

Class	0-20	20-40	40-60	60-80	80-100	100-120
Frequency	5	f_1	10	f_2	7	8

33. A train, travelling at a uniform speed for 360 km, would have taken 48 minutes less to travel the same distance if its speed were 5 km/h more. Find the original speed of the train.

OR

Two water taps together can fill a tank in 6 hours. The tap of larger diameter takes 9 hours less than the smaller one to fill the tank separately. Find the time in which each tap can separately fill the tank.

34. 200 logs are stacked in the following manner: 20 logs in the bottom row, 19 in the next row, 18 in the row next to it and so on (see below figure). In how many rows are the 200 logs placed and how many logs are in the top row?

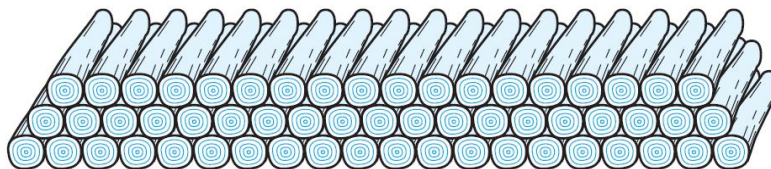

OR

The sum of the third and the seventh terms of an AP is 6 and their product is 8. Find the sum of first sixteen terms of the AP.

35. Prove that if a line is drawn parallel to one side of a triangle intersecting the other two sides in distinct points, then the other two sides are divided in the same ratio. Using the above theorem.

Prove that $\frac{AM}{MB} = \frac{AN}{ND}$ if $LM \parallel CB$ and $LN \parallel CD$ as shown in the figure.

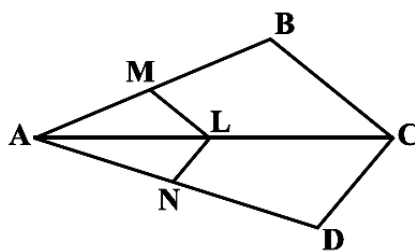

SECTION-E (Case Study Based Questions)

Questions 36 to 38 carry 4M each

36. Mayank a student of class 7th loves watching and playing with birds of different kinds. One day he had an idea in his mind to make a bird-bath on his garden. His brother who is studying in class 10th helped him to choose the material and shape of the birdbath. They made it in the shape of a cylinder with a hemispherical depression at one end as shown in the Figure below. They opted for the height of the hollow cylinder as 1.45 m and its radius is 30 cm. The cost of material used for making bird bath is Rs. 40 per square meter.

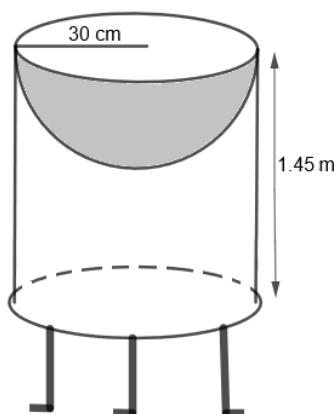

- Find the curved surface area of the hemisphere. (Take $\pi = 3.14$)
- Find the total surface area of the bird-bath. (Take $\pi = 22/7$)
- What is total cost for making the bird bath?

OR

(iii) Mayank and his brother thought of increasing the radius of hemisphere to 35 cm with same material so that birds get more space, then what is the new height of cylinder?

37. Tower Bridge is a Grade I listed combined bascule and suspension bridge in London, built between 1886 and 1894, designed by Horace Jones and engineered by John Wolfe Barry. The bridge is 800 feet (240 m) in length and consists of two bridge towers connected at the upper level by two horizontal walkways, and a central pair of bascules that can open to allow shipping. In this bridge, two towers of equal heights are standing opposite each other on either side of the road, which is 80 m wide. During summer holidays, Neeta visited the tower bridge. She stood at some point on the road between these towers. From that point between the towers on the road, the angles of elevation of the top of the towers was 60° and 30° respectively.

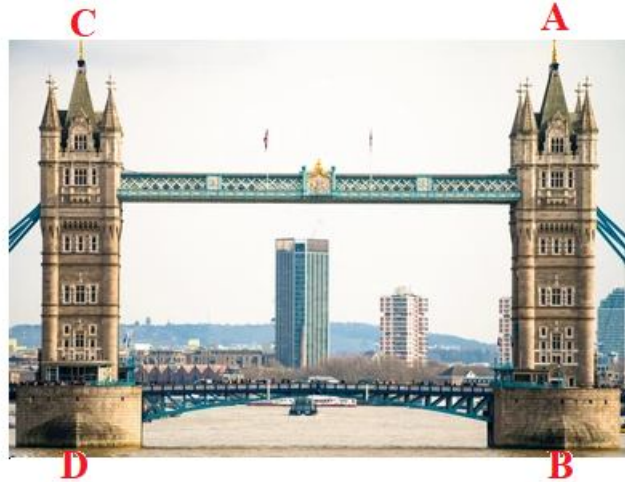

- (i) Find the distances of the point from the base of the towers where Neeta was standing while measuring the height. [2]
(ii) Neeta used some applications of trigonometry she learned in her class to find the height of the towers without actually measuring them. What would be the height of the towers she would have calculated? [2]

OR

- (ii) Find the distance between Neeta and top of tower AB? Also, Find the distance between Neeta and top tower CD? [2]

38. On the roadway, Points A and B, which stand in for Chandigarh and Kurukshetra, respectively, are located nearly 90 kilometres apart. At the same time, a car departs from Kurukshetra and one from Chandigarh. These cars will collide in 9 hours if they are travelling in the same direction, and in $9/7$ hours if they are travelling in the other direction. Let X and Y be two cars that are travelling at x and y kilometres per hour from places A and B, respectively. On the basis of the above information, answer the following questions:

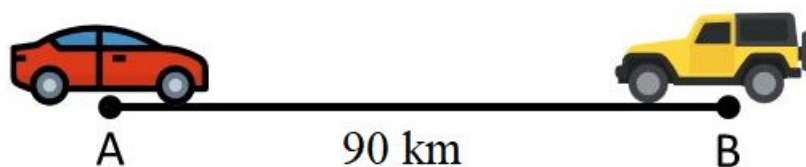

- (a) When both cars move in the same direction, then find the situation which can be represented algebraically. [2]

OR

- (a) When both cars move in the opposite direction, then find the situation which can be represented algebraically. [2]
(b) Find the speed of car x. [1]
(c) Find the speed of car y. [1]